

TORQUE SPECIFICATIONS			
ITEM	FT-LB	IN-LB	N-M
8	9	106	12
7	15	177	20
15	13	159	18
21	15	177	20
24	15	177	20
46	15	177	20
49	7	80	9
67	7	80	9
68	18	221	25
73	3	35	4
77	13	159	18
93	15	177	20
97	13	159	18

		REVISIONS		
REV.	DESCRIPTION	ECN#	APPROVED	DATE
A	NEW RELEASE	DC16-0005	Don H.	1/6/2016

530010 / 10.0GA13 530012 / 9.4GA13-1

530010, 530012 PUMP SERVICE DRAWING

PUMPS	
PART NO.	MODEL
530010	10mm
530012	9.4mm

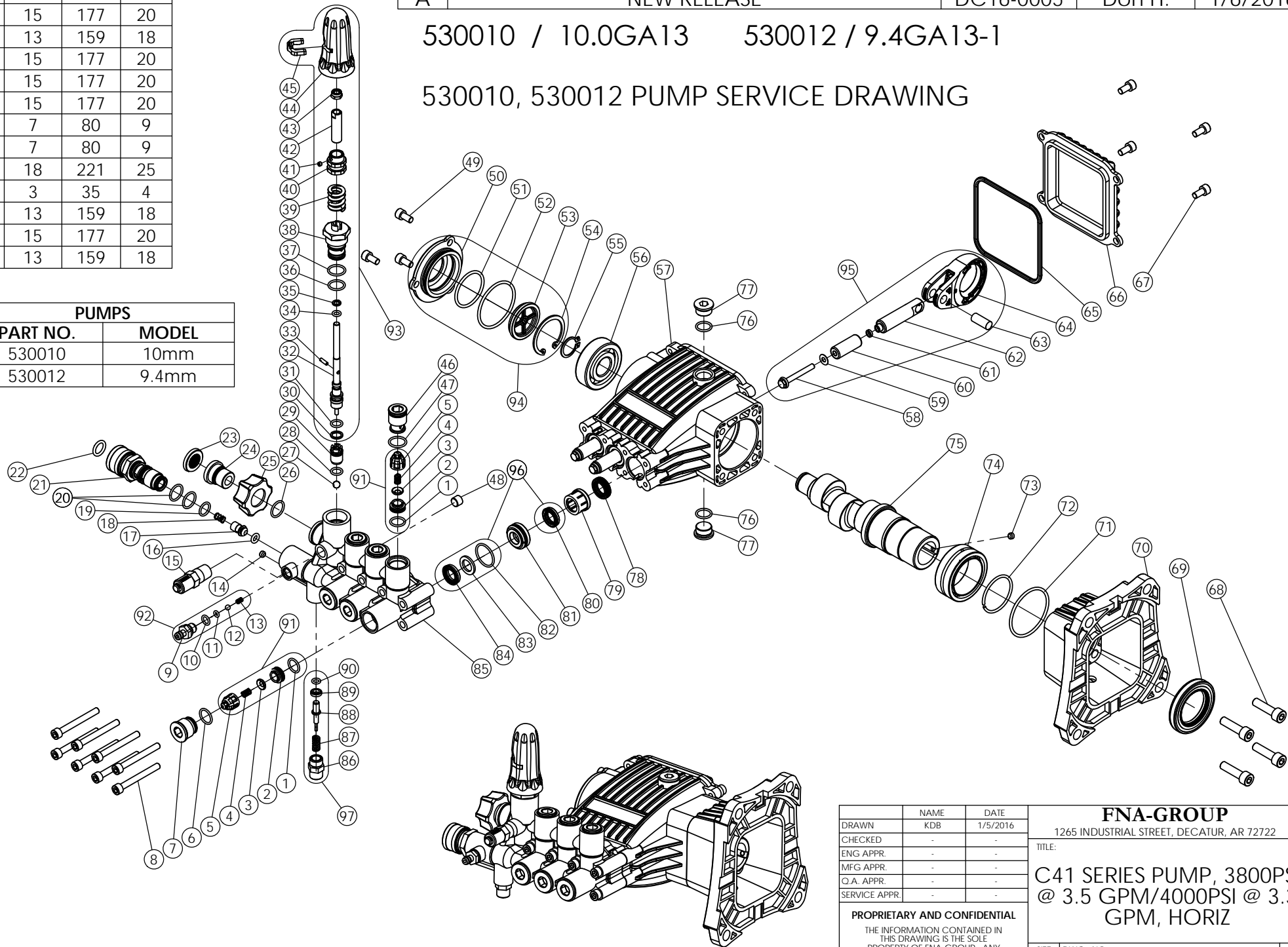

	NAME	DATE
DRAWN	KDB	1/5/2016
CHECKED	-	-
ENG APPR	-	-
MFG APPR	-	-
Q.A. APPR	-	-
SERVICE APPR	-	-

FNA-GROUP
 1265 INDUSTRIAL STREET, DECATUR, AR 72722
 TITLE:
C41 SERIES PUMP, 3800PSI @ 3.5 GPM/4000PSI @ 3.3 GPM, HORIZ

PROPRIETARY AND CONFIDENTIAL
 THE INFORMATION CONTAINED IN THIS DRAWING IS THE SOLE PROPERTY OF FNA-GROUP. ANY REPRODUCTION IN PART OR AS A WHOLE WITHOUT THE WRITTEN PERMISSION OF FNA-GROUP IS PROHIBITED.

SIZE	DWG. NO.	REV.
A	530010, 530012	A
SCALE: N/A	ECN# DC16-0005	SHEET 1 OF 5

530010, 530012 PARTS LIST

ITEM	PART NO.	DESCRIPTION	QTY
1	N/A	O-RING	6
2	N/A	SEAT, VALVE	6
3	N/A	DISK, VALVE	6
4	N/A	SPRING, VALVE	6
5	N/A	CAGE, VALVE	6
6	7106694	O-RING	3
7	7106693	PLUG	3
8	7106692	SCREW	8
9	N/A	HOSE BARB	1
10	N/A	O-RING	1
11	N/A	O-RING	1
12	N/A	BALL, SOAP VALVE	1
13	N/A	SPRING, SOAP VALVE	1
14	7106695	SCREW	1
15	7101359	VALVE, THERMAL RELIEF	1
16	7106696	O-RING, CHECK VALVE	1
17	7106697	CORE, CHECK VALVE	1
18	7106698	SPRING, CHECK VALVE	1
19	7106699	O-RING	1
20	7106700	O-RING	2
21	7106701	QUICK CONNECT CONNECTOR, OUTLET	1
22	7106702	O-RING	1
23	7000123	SCREEN, WATER INLET	1
24	7106703	INLET CONNECTOR	1
25	7105705	NUT, HAND TIGHT	1
26	7106704	O-RING	1
27	7105710	BALL	1
28	7106705	O-RING	2
29	7106706	UNLOADER VALVE BASE	1
30	N/A	BACK UP RING	1
31	N/A	O-RING, 9X1.8	1
32	N/A	STEM ASSY	1
33	N/A	LOCK PIN	1
34	N/A	O-RING, 5.6X1.8	1
35	N/A	BACK UP RING	1
36	N/A	O-RING, 14X1.8	1
37	N/A	O-RING, 15X1.8	1
38	N/A	UNLOADER VALVE CAP	1
39	N/A	UNLOADER SPRING	1
40	N/A	UNLOADER NUT	1
41	N/A	SET SCREW	1
42	N/A	SCREW	1
43	N/A	NUT M6	1
44	N/A	UNLOADER CAP	1
45	N/A	CAP LOCKER	1
46	7106707	PLUG	3
47	7106700	O-RING	3
48	7106647	PLUG	1
49	7106721	SCREW	3
50	N/A	COVER, SIDE	1
51	N/A	O-RING	1
52	N/A	O-RING	1
53	N/A	SIGHT GLASS	1
54	N/A	RING Ø40, RETAINING	1

530010, 530012 PARTS LIST

ITEM	PART NO.	DESCRIPTION	QTY
55	7106714	RING Ø20, RETAINING	1
56	7106715	BEARING, 6304	1
57	7106716	CRANKCASE	1
58	N/A	BOLT	1
59	N/A	GASKET	1
60	N/A	PISTON, CERAMIC	1
61	N/A	RING	1
62	N/A	PLUNGER, POLE, BASE	1
63	N/A	PIN, CONNECTING ROD	1
64	N/A	CONNECTING ROD	1
65	7106719	O-RING	1
66	7106720	END COVER	1
67	7106721	SCREW	4
68	7106722	SCREW	4
69	7106723	OIL SEAL	1
70	7106724	FLANGE	1
71	7106712	O-RING	1
72	7106726	RING Ø40, RETAINING	1
73	7106729	SET SCREW	1
74	7106727	NEEDLE BEARING	1
75	-	CRANKSHAFT	-
-	7106672	CRANKSHAFT, Ø10mm	1
-	7106728	CRANKSHAFT, Ø9.4mm	1
76	7106730	O-RING	2
77	7105721	PLUG	2
78	7106731	OIL SEAL	3
79	7106732	RETAINER, SEAL	3
80	N/A	SEAL, LOW PRESSURE	1
81	7106710	RETAINER	3
82	N/A	O-RING	1
83	N/A	RING, ANTI-EXT	1
84	N/A	SEAL, HIGH PRESSURE	1
85	7106734	PUMP HEAD	1
86	N/A	VALVE CAP, PRESSURE BOOST	1
87	N/A	SPRING, BOOST VALVE	1
88	N/A	VALVE, PRESSURE BOOST	1
89	N/A	BACK RING	1
90	N/A	O-RING	1

530010, 530012 KITS

ITEM	PART NO.	DESCRIPTION	QTY
91	7108750	VALVE KIT	6
92	7104228	SOAP INJECTOR KIT	1
93	7108747	UNLOADER KIT	1
94	7106709	CRANKCASE SIDE COVER KIT	1
95	7108751	CONNECTING ROD KIT	3
96	7106733	HIGH AND LOW PRESSURE SEAL KIT	3
97	7106628	PRESSURE BOOST VALVE KIT	1
98	7108752	MANIFOLD KIT	1
99	-	CRANKCASE KIT	-
-	7108753	CRANKCASE KIT 10mm	1
-	7108754	CRANKCASE KIT 9.4mm	1

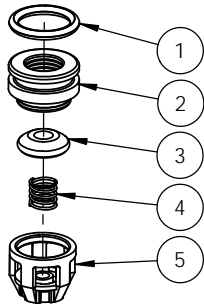

91 **PART NO. 7108750**
VALVE KIT

ITEM	QTY	DESCRIPTION
1	6	O-RING
2	6	SEAT, VALVE
3	6	DISK, VALVE
4	6	SPRING, VALVE
5	6	CAGE, VALVE

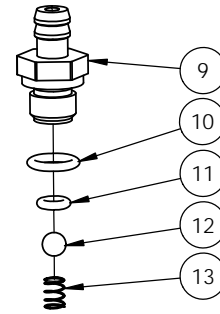

92 **PART NO. 7104228**
SOAP INJECTOR KIT

ITEM	QTY	DESCRIPTION
9	1	HOSE BARB
10	1	O-RING
11	1	O-RING
12	1	BALL, SOAP VALVE
13	1	SPRING, SOAP VALVE

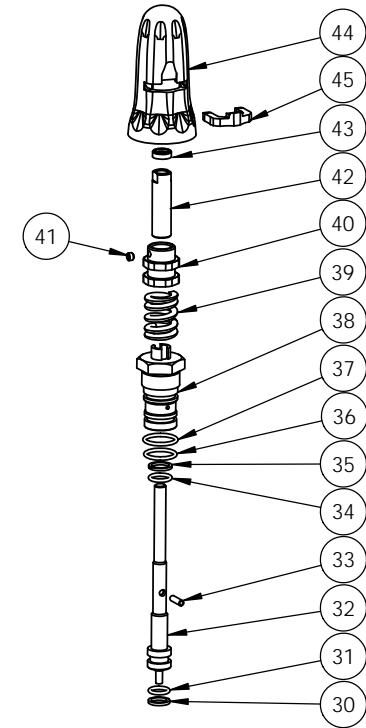

93 **PART NO. 7108747**
UNLOADER KIT

ITEM	QTY	DESCRIPTION
30	1	BACK UP RING
31	1	O-RING, 9X1.8
32	1	STEM ASSY
33	1	LOCK PIN
34	1	O-RING, 5.6X1.8
35	1	BACK UP RING
36	1	O-RING, 14X1.8
37	1	O-RING, 15X1.8
38	1	UNLOADER VALVE CAP
39	1	UNLOADER SPRING
40	1	UNLOADER NUT
41	1	SET SCREW
42	1	SCREW
43	1	NUT M6
44	1	UNLOADER CAP
45	1	CAP LOCKER

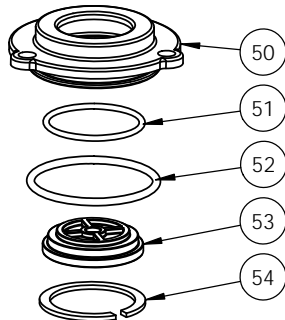

94 **PART NO. 7106709**
CRANKCASE SIDE COVER KIT

ITEM	QTY	DESCRIPTION
50	1	COVER, SIDE
51	1	O-RING
52	1	O-RING
53	1	SIGHT GLASS
54	1	RING Ø40, RETAINING

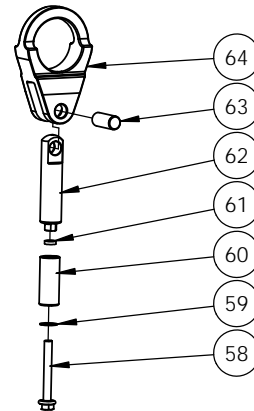

95 **PART NO. 7105741**
OIL SEAL KIT

ITEM	QTY	DESCRIPTION
58	1	BOLT
59	1	GASKET
60	1	PISTON, CERAMIC
61	1	RING
62	1	PLUNGER, POLE, BASE
63	1	PIN, CONNECTING ROD
64	1	CONNECTING ROD

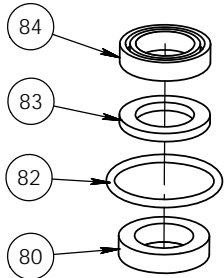

96 PART NO. 7106733
HIGH AND LOW PRESSURE SEAL KIT

ITEM	QTY	DESCRIPTION
80	3	SEAL, LOW PRESSURE
82	3	O-RING
83	3	RING, ANTI-EXT
84	3	SEAL, HIGH PRESSURE

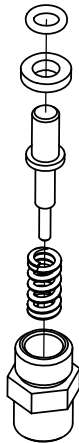

97 PART NO. 7106628
PRESSURE BOOST VALVE KIT

ITEM	QTY	DESCRIPTION
23	1	CAP, BOOST VALVE
24	1	SPRING, POWER BOOST VALVE
25	1	VALVE, PRESSURE BOOST
26	1	O-RING
22	1	BODY, SOAP INJECTOR
13	1	O-RING
27	1	O-RING

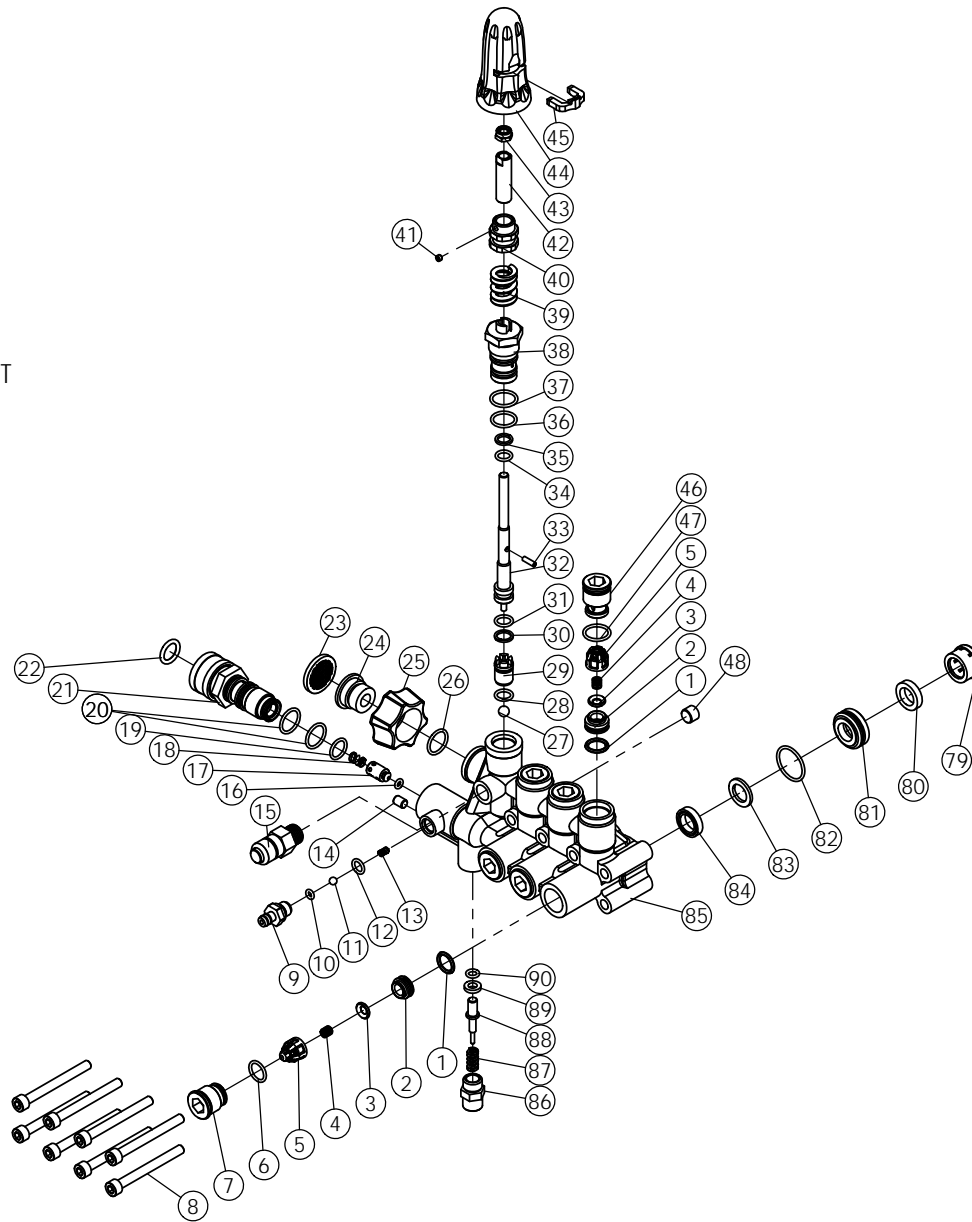

98 PART NO. 7108752
MANIFOLD KIT

ITEM	QTY	DESCRIPTION
1	1	SCREEN, WATER INLET
2	1	CONNECTOR, WATER INLET
3	1	NUT, HAND TIGHT
4	3	SCREW
5	3	SCREW
6	1	SCREW, SET
7	1	VALVE, THERMAL RELIEF
8	1	MANIFOLD
9	1	NUT, UNLOADER JAM
10	1	NUT, UNLOADER ADJUSTMENT
11	1	SPRING, UNLOADER
12	1	GUIDE BUSHING, UNLOADER
13	2	O-RING
14	1	BACK-UP RING, UNLOADER VALVE
15	1	O-RING
16	1	STEM, UNLOADER
17	1	O-RING
18	1	BACK-UP RING, SPLIT
19	1	VALVE SEAT
20	1	O-RING
21	1	BALL, UNLOADER VALVE
22	1	BODY, SOAP INJECTOR
23	1	CAP, BOOST VALVE
24	1	SPRING, BOOST VALVE
25	1	VALVE, PRESSURE BOOST
26	1	O-RING
27	1	O-RING
28	1	SPRING, CHECK VALVE
29	1	CHECK VALVE
30	1	O-RING
31	1	FITTING, SOAP INJECTION
32	1	O-RING
33	1	O-RING
34	1	BALL, 3/16" SOAP VALVE
35	1	SPRING, SOAP VALVE
36	3	PLUG, MANIFOLD
37	3	O-RING
38	6	CAGE, VALVE
39	6	SPRING, VALVE
40	6	DISK, VALVE
41	6	SEAT, VALVE
42	6	O-RING
43	3	SEAL, HIGH PRESSURE
44	3	RING, ANTI-EXT
45	3	RETAINER
46	3	O-RING
47	3	SEAL, LOW PRESSURE
48	3	RETAINER, SEAL

99 CRANKCASE KIT

PUMP MODEL	PART NO.	DESCRIPTION
530010	7108753	CRANKCASE KIT 10mm
530012	7108754	CRANKCASE KIT 9.4mm

ITEM	QTY	DESCRIPTION
49	2	SCREW
50	3	COVER, SIDE
51	3	O-RING
52	2	O-RING
53	1	SIGHT GLASS
54	1	RING Ø40, RETAINING
55	1	RING Ø20, RETAINING
56	1	BEARING, 6304
57	1	CRANKCASE
58	1	BOLT
59	1	GASKET
60	1	PISTON, CERAMIC
61	1	RING
62	1	PLUNGER, POLE, BASE
63	1	PIN, CONNECTING ROD
64	1	CONNECTING ROD
65	1	O-RING
66	1	END COVER
67	4	SCREW
68	4	SCREW
69	1	OIL SEAL
70	1	FLANGE
71	1	O-RING
72	1	RING Ø40, RETAINING
73	1	SET SCREW
74	1	NEEDLE BEARING
75	-	CRANKSHAFT
-	1	CRANKSHAFT, Ø10mm
-	1	CRANKSHAFT, Ø9.4mm
76	2	O-RING
77	2	PLUG
78	3	OIL SEAL

